

# What you should have done so far...

- Check if you have a gitlab repository (gitlab.inf.ethz.ch) -- if not, email your TA!
- Give us TAs access to it:

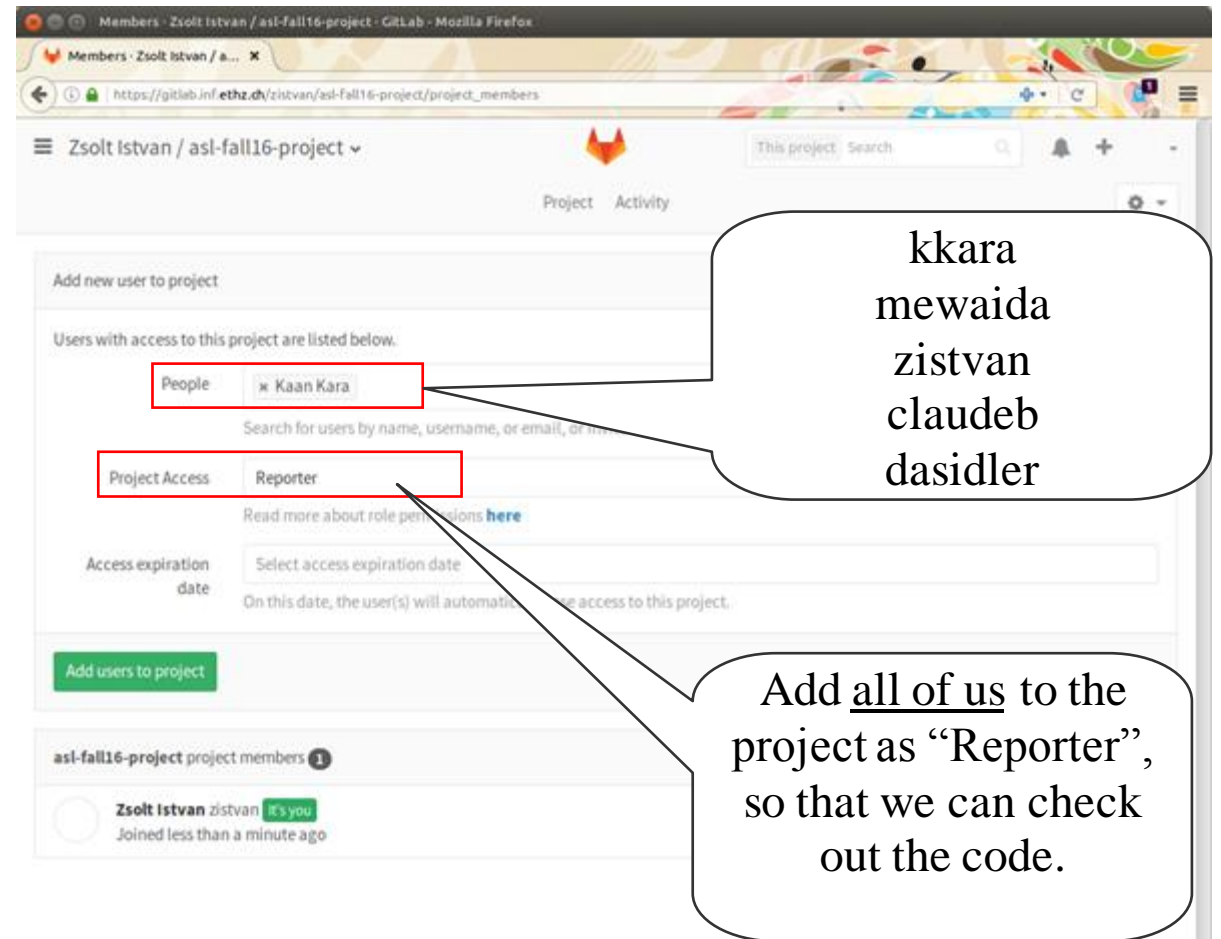
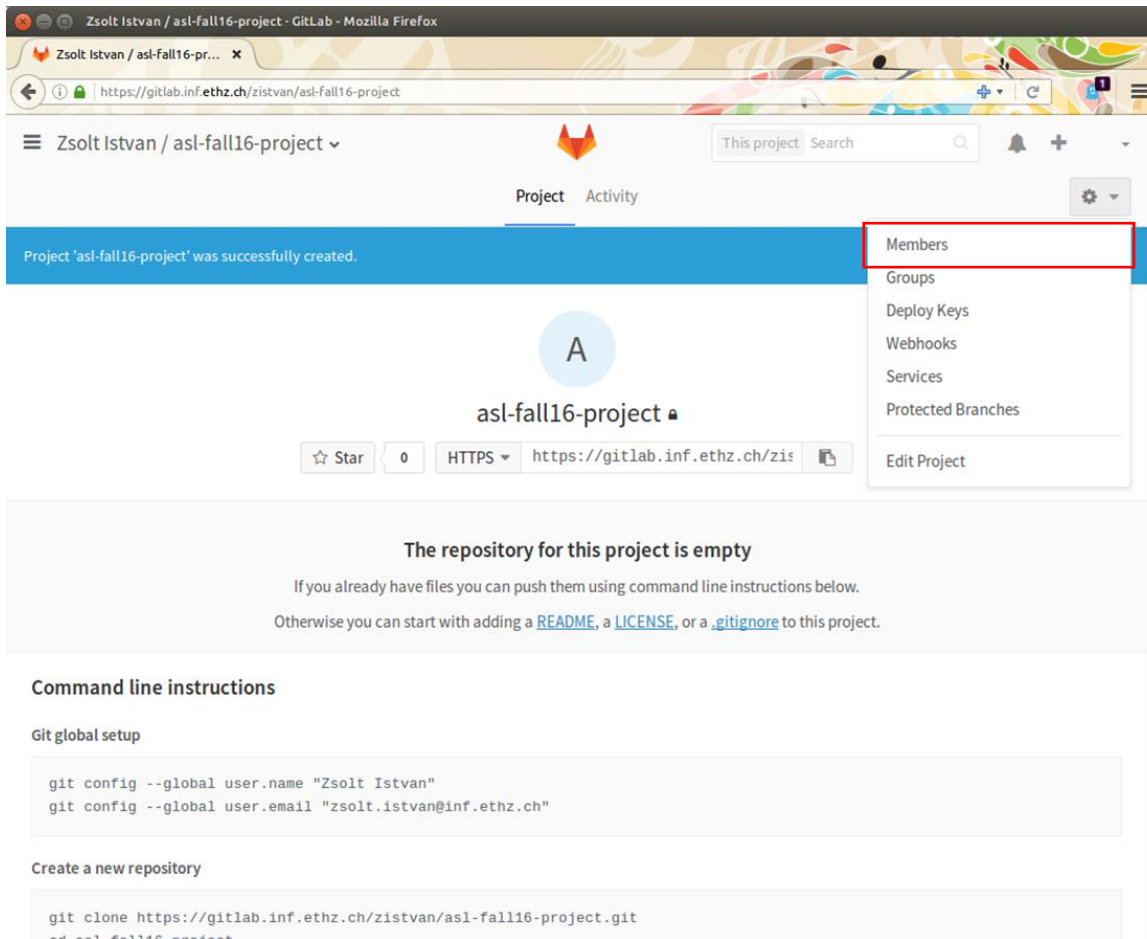

# What you should have done so far...

- Have a Microsoft account: One that you can log in to Azure.
- Send us that email address and your nethz ID.
- You will get an Azure voucher from your TA.

# What you should have done so far...

- Understand what you need to implement for the first milestone.

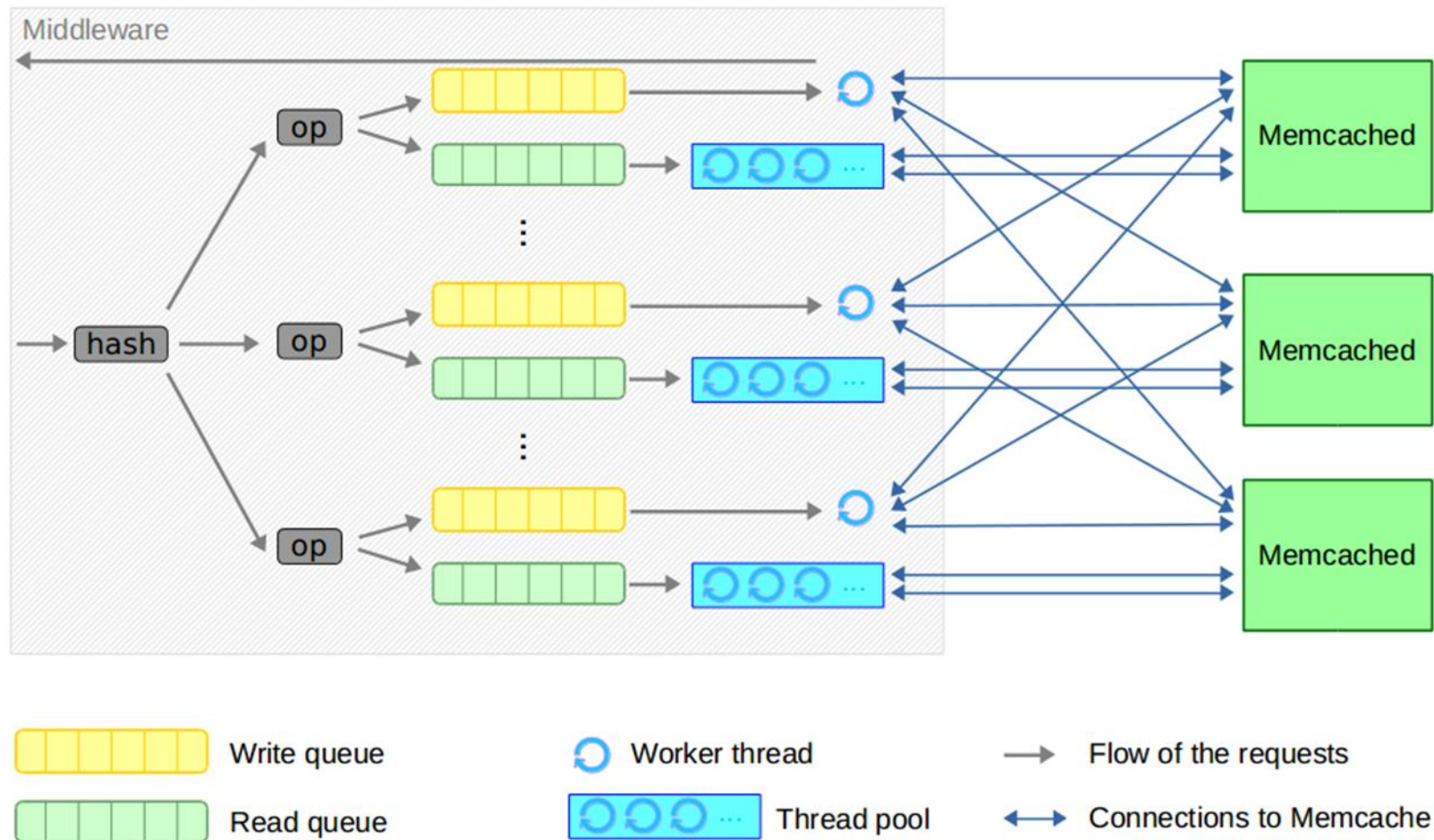

# FAQ

- Are we allowed to use memcached client libraries in our middleware?
  - No external memcached client libraries allowed in your middleware.
- Do we need to implement the binary protocol?
  - Do not implement the binary protocol. Just look at the ASCII specification.
- Do we need to implement the multi-get?
  - Do not implement multi-get. All operations use only a single key.
- The keys generated by memaslapp has some non ASCII characters. What should I do?
  - The key generated by memaslapp might have some characters that are not printable in standard ASCII encoding. However, they will not contain whitespace or newline characters. The middleware must not modify keys (even if some characters are “funny”)

# Remarks

- The latex template for the first milestone has changed. Please download the recent version from the webpage:  
<http://systems.ethz.ch/courses/fall2016/asl>
- For memaslap use the command below **as default way** of starting experiments. If you want to change parameters make sure you explain it in the report.

```
$ ./clients/memaslap -s ip_of_server_vm:11212 -T 64 -c 64 -o1 -S 1s -t <runtime> -F <path/to/configfile>
```

- We provided on the website a set of workload files. Start by default with the **small workload (16B key, 128B value, 1% writes)**

# What you should do this week...

- Set up your development environment:
  - Recommended IDE: Eclipse. Use it during development to debug.
  - End build: Ant. We will provide a script and a wrapper class.

```
./YourProjectRoot  
| ./src/ch/ethz/asltest/RunMW.java (here additional .java files you wrote)  
| ./build.xml
```

```
Ant script
```

```
Wrapper class
```

To build:

1. Install ant: `$ sudo apt-get install ant`
2. `$ cd /path/to/YourProjectRoot/`
3. Open build.xml. Replace YOURETHZID with your ethz ID. Save.
4. `$ ant`

To run:

```
$ java -jar ./dist/middleware- $\{nethzid\}$ .jar [options]
```

# What you should do this week...

- Take a look at the wrapper `RunMW.java`
- Options:
  1. `-l <MyIP>`: External IP of the middleware VM.
  2. `-p <MyListenPort>`: Port that the middleware listens to.
  3. `-t <NumberOfThreadsInPools>`
  4. `-r <WriteToThisManyServers>`: Replication strategy (1: No replication)
  5. `-m <MemcachedIP:Port> <MemcachedIP2:Port2> ...`
- You have to use this wrapper!
- And, start with development if you haven't already done so.

# Azure Tutorial

- Accepting the voucher and logging in
- Use the template script provided to create VMs
- SSH into a server VM and install memcached
- SSH into a client VM and install memaslap
- Run a baseline experiment



# Validate the voucher and log in to portal

- Go to: <https://www.microsoftazurepass.com/>
- Select country: Switzerland
- Put the voucher code and click submit
- Log in to portal.azure.com
- Under subscriptions you should see your Azure Pass
- Check usage to see how much money you have left
- 85 Euros/month should be more than enough, if you just create the VMs we provide in the template

# Submit a request to raise core quota

1.

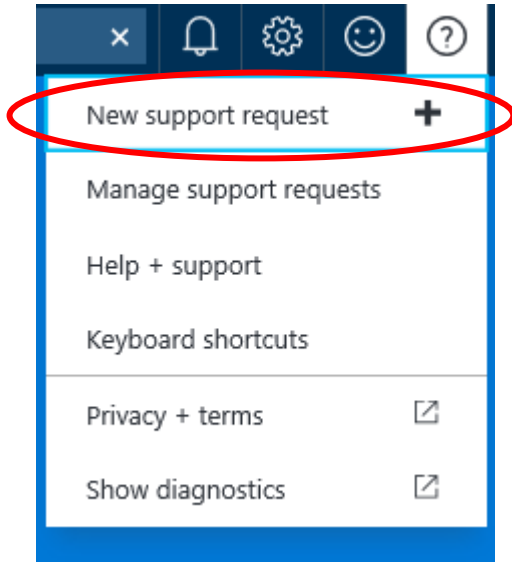

2.

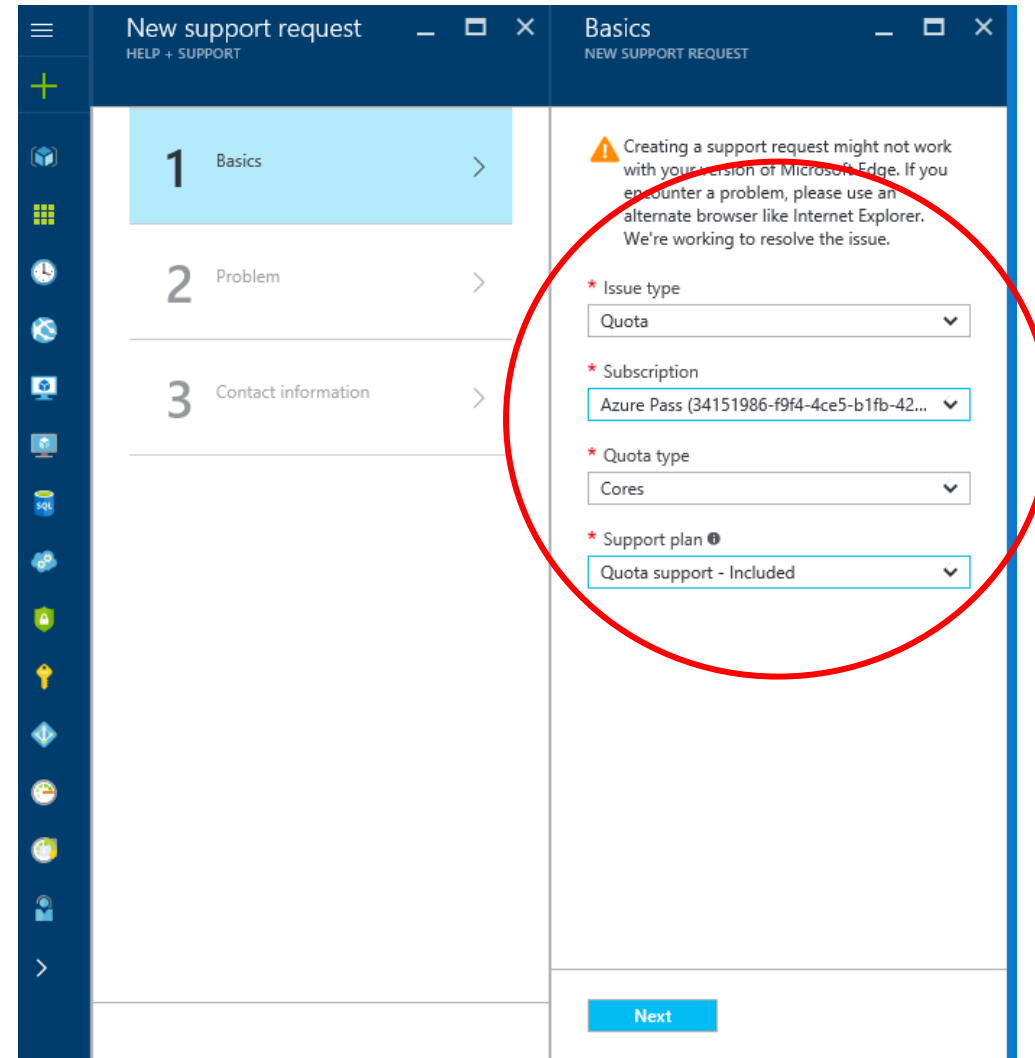

# Submit a request to raise core quota

3.

New support request  
HELP + SUPPORT

1 Basics ✓

2 Problem >

3 Contact information >

\* Severity ⓘ  
C - Minimal impact

\* Deployment model ⓘ  
Resource Manager

\* Location ⓘ  
West Europe

\* SKU family ⓘ  
4 selected

- A Series
- Dv2 Series
- F Series
- D Series
- DSv2 Series
- FS Series
- G Series
- GS Series
- A Series - compute intensive

Next

4.

New support request  
HELP + SUPPORT

1 Basics ✓

2 Problem >

3 Contact information >

\* Severity ⓘ  
C - Minimal impact

\* Deployment model ⓘ  
Resource Manager

\* Location ⓘ  
West Europe

\* SKU family ⓘ  
4 selected

Current quota (Cores)  
10

New quota (Cores)  
60 ✓

[Learn more about Azure quotas](#)

Next

5. Then, fill in the contact info and create the request.

# Use the template to create VMs

1. Launch Template Deployment on Azure.
2. Name for the VMs, network interface, vnet already given.
3. Generate a public SSH key and copy it to the template.
4. Put in your nethz (it will be used as unique DNS name and admin username).
5. Give an admin password.
6. Start deployment.

# Use the template to create VMs

1.

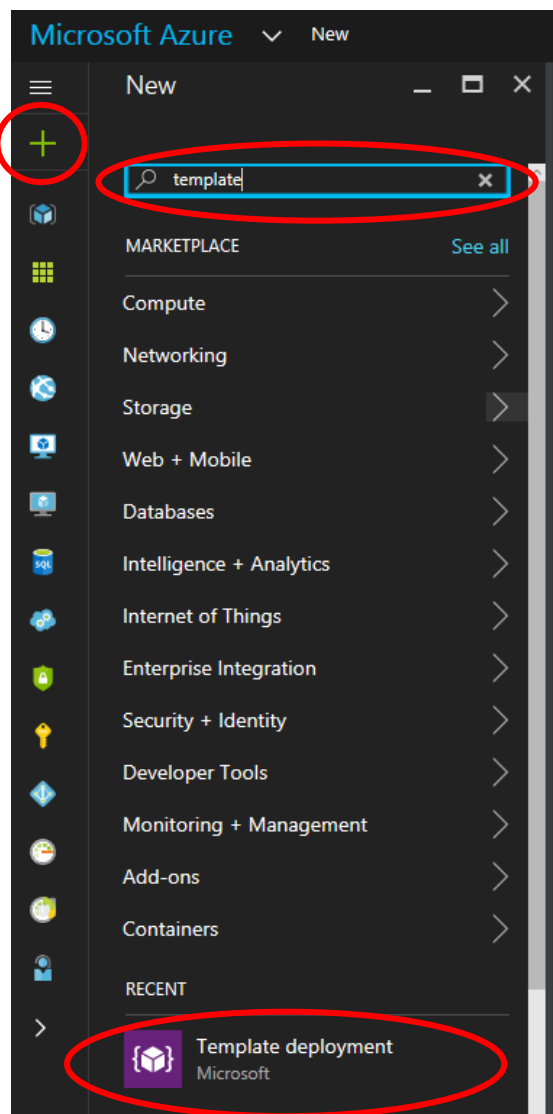

2.

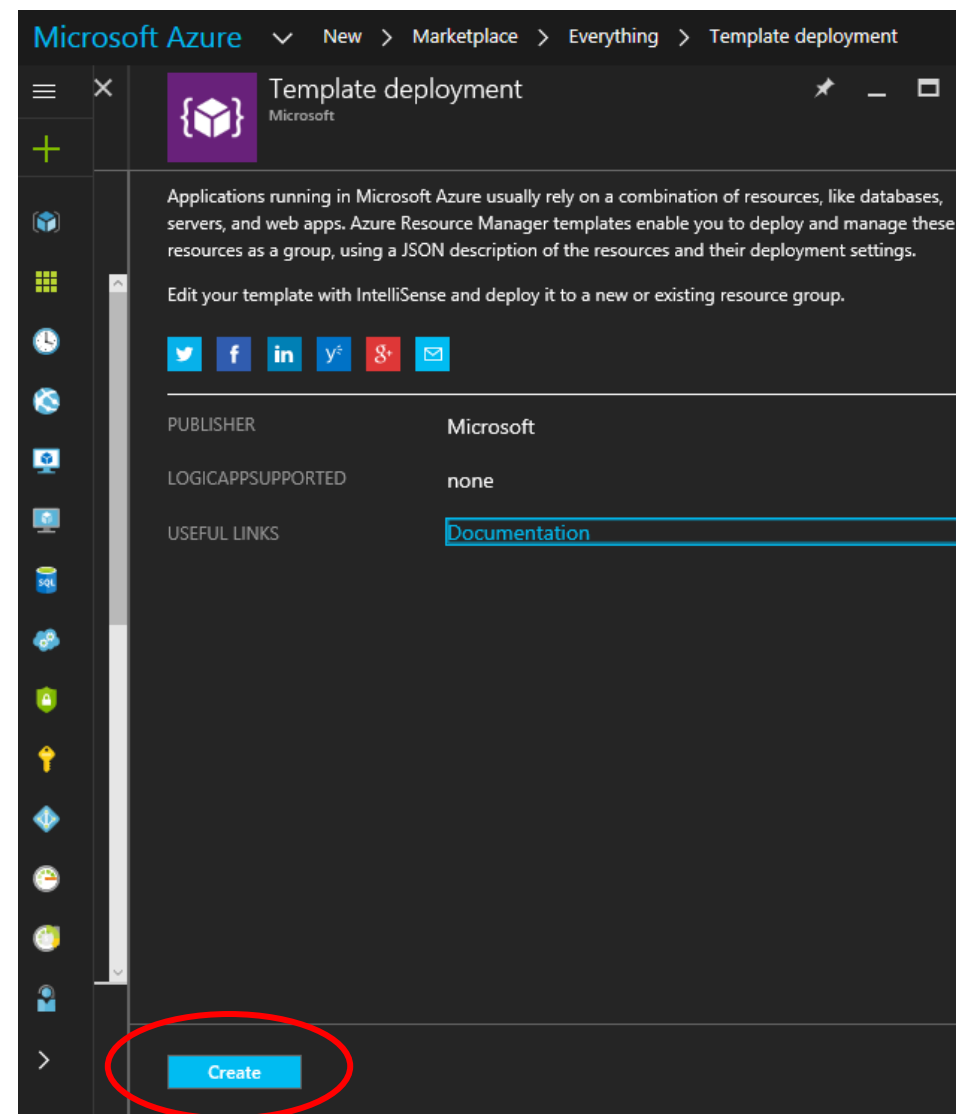

# Use the template to create VMs

3.

Microsoft Azure > Template deployment > Custom deployment > Edit template

Custom deployment  
Deploy from a custom template

- Template (circled in red)
  - Edit template
- Parameters
  - Edit parameters
- Subscription
  - Azure Pass
- Resource group
  - Create new  Use existing
- Resource group location
  - West Europe
- Legal terms
  - Review legal terms

Parameters (0)  
Variables (0)  
Resources (0)

```
1 {  
2   "$schema": "http://schema.management.azure.com/schemas/2015-01-08/  
3   "contentVersion": "1.0.0.0",  
4   "parameters": {},  
5   "resources": []  
6 }
```

Copy&Paste the provided template

Then click Save

Create Save Discard

# Use the template to create VMs

4.

Microsoft Azure

Template deployment > Custom deployment > Parameters

Custom deployment  
Deploy from a custom template

Parameters  
Customize your template parameters

\* Template  
Edit template

Parameters  
Edit parameters

\* Subscription  
Azure Pass

\* Resource group  
 Create new  Use existing

\* Resource group location  
West Europe

\* Legal terms  
Review legal terms

Pin to dashboard

Create OK

Name your VMs, however you want  
BUT small case letters!

Give a password for the local admin  
(You will use it for sudo on the VM later on)

Generate an SSH key and copy the public key  
here. See  
<https://gitlab.inf.ethz.ch/help/ssh/README>

Your ETHZ\_ID

# Use the template to create VMs

5.

The screenshot displays the 'Purchase' step of a custom deployment in the Microsoft Azure portal. The left sidebar contains configuration options, and the main pane displays legal terms and a 'Purchase' button. Five red circles with numbers 1-5 highlight key elements:

- 1. Subscription dropdown menu, currently set to 'Azure Pass'.
- 2. Resource group dropdown menu, currently set to 'For\_ASL'.
- 3. 'Review legal terms' link.
- 4. 'Purchase' button.
- 5. 'Create' button.

The main pane contains the following text:

Deploying this template will result in various actions being performed, which may include the deployment of one or more Azure resources or Marketplace offerings and/or transmission of the information you provided as part of the deployment process to one or more parties, as specified in the template. You are responsible for reviewing the text of the template to determine which actions will be performed and which resources or offerings will be deployed, and for locating and reviewing the pricing and legal terms associated with those resources or offerings.

Current retail prices for Azure resources are set forth [here](#) and may not reflect discounts applicable to your Azure subscription.

Prices for Marketplace offerings are set forth [here](#), and the legal terms associated with any Marketplace offering may be found in the Azure portal; both are subject to change at any time prior to deployment.

Neither subscription credits nor monetary commitment funds may be used to purchase non-Microsoft offerings. These purchases are billed separately. If any Microsoft products are included in a Marketplace offering (e.g., Windows Server or SQL Server), such products are licensed by Microsoft and not by any third party.

**Template deployment is intended for advanced users only.** If you are uncertain which actions will be performed by this template, which resources or offerings will be deployed, or what prices or legal terms pertain to those resources or offerings, do not deploy this template.

**Terms of use**

By clicking "Purchase," I (a) agree to the legal terms and privacy statement(s) provided above as well as the legal terms and privacy statement(s) associated with each Marketplace offering that will be deployed using this template, if any; (b) authorize Microsoft to charge or bill my current payment method for the fees associated with my use of the offering(s), including applicable taxes, with the same billing frequency as my Azure subscription, until I discontinue use of the offering(s); and (c) agree that Microsoft may share my contact information and transaction details with any third-party sellers of the offering(s). Microsoft assumes no responsibility for any actions performed by third-party templates and does not provide rights for third-party products or services. See the [Azure Marketplace Terms](#) for additional terms.



# After you have created the VMs...

The screenshot displays the Azure portal interface. On the left, a table lists several virtual machines (vmstest1 through vmstest9) and network interfaces (aslinet1 through aslinet2) in the West Europe region. The main pane shows the details for the 'vmstest1' VM. The 'Essentials' section includes fields for Resource group (ForASLTest), Status (Running), Location (West Europe), Subscription name (Azure Pass), and Subscription ID (34151986-f9f4-4ce5-b1fb-4208acbb2747). The 'Size' field is highlighted with a red circle and contains the text 'Basic A2 (2 cores, 3.5 GB memory)'. The 'Public IP address/DNS name label' field is also highlighted with a red circle and contains the value '13.94.157.91/kkaravmstest1.westeurope.c'. Below this, the 'Monitoring' section shows a CPU usage graph with a current value of 0.96%.

NAME	TYPE	LOCATION
vmstest1	Virtual machine	West Europe
vmstest10	Virtual machine	West Europe
vmstest11	Virtual machine	West Europe
vmstest2	Virtual machine	West Europe
vmstest3	Virtual machine	West Europe
vmstest4	Virtual machine	West Europe
vmstest5	Virtual machine	West Europe
vmstest6	Virtual machine	West Europe
vmstest7	Virtual machine	West Europe
vmstest8	Virtual machine	West Europe
vmstest9	Virtual machine	West Europe
aslinet1	Network inter...	West Europe
aslinet10	Network inter...	West Europe
aslinet11	Network inter...	West Europe
aslinet2	Network inter...	West Europe

**Essentials**

- Resource group: ForASLTest
- Status: Running
- Location: West Europe
- Subscription name: Azure Pass
- Subscription ID: 34151986-f9f4-4ce5-b1fb-4208acbb2747
- Computer name: vmstest1
- Operating system: Linux
- Size: Basic A2 (2 cores, 3.5 GB memory)
- Public IP address/DNS name label: 13.94.157.91/kkaravmstest1.westeurope.c
- Virtual network/subnet: subnet/default

**Monitoring**

CPU percentage

0.96%

Use the hostname or the public IP to ssh into the VM

# SSH into a server VM (choose one of Basic\_A2)

- `ssh your_nethz@hostname_of_vm`
- `sudo apt-get update`
- `sudo apt-get install build-essential libevent-dev memcached`
- `memcached -p 11212 -t 1`

Starts memcached on port 11212

# SSH into a client VM (choose one of Basic\_A2)

- `ssh your_nethz@hostname_of_vm`
- `sudo apt-get update`
- `sudo apt-get install build-essential libevent-dev`
- `wget https://Launchpad.net/libmemcached/1.0/1.0.18/+download/libmemcached-1.0.18.tar.gz`
- `tar xvf libmemcached-1.0.18.tar.gz`
- `cd libmemcached-1.0.18`
- `export LDFLAGS=-lpthread`
- `./configure --enable-memaspap && make clients/memaspap`
- `./clients/memaspap -s ip_of_server_vm:11212 -T 64 -c 64 -o1 -S 1s -t 1s`

Starts memaspap

Attention!: This is the private IP of the VM. (e.g. 10.0.0.X)

# SSH into the middleware VM (choose one of Basic\_A4)

- `ssh your_nethz@hostname_of_vm`
- `sudo apt-get update`
- `sudo apt-get openjdk-7-jre`
- (If you want to build on the VM) `sudo apt-get openjdk-7-jdk ant`